

-
-

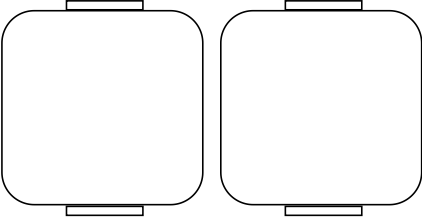

: (),
()

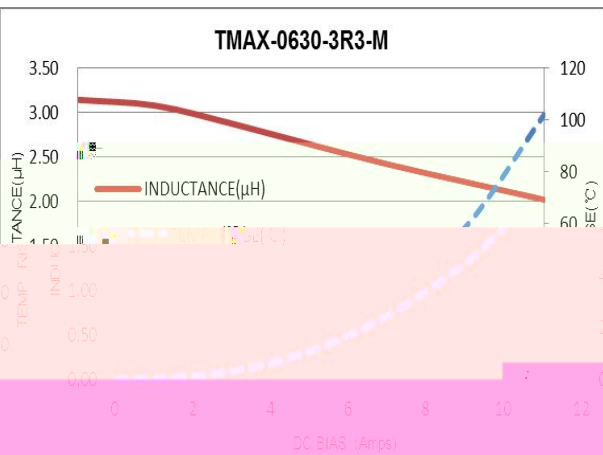

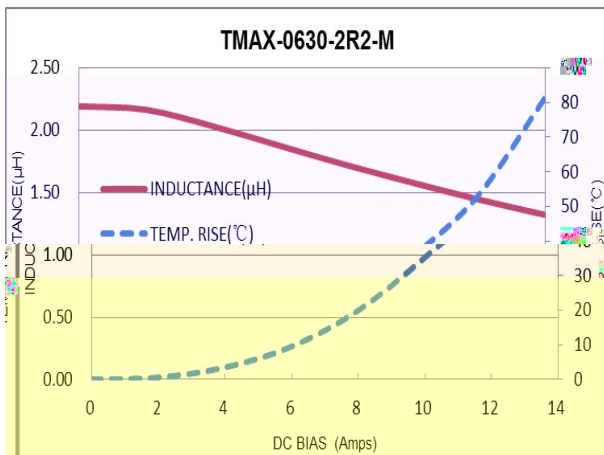
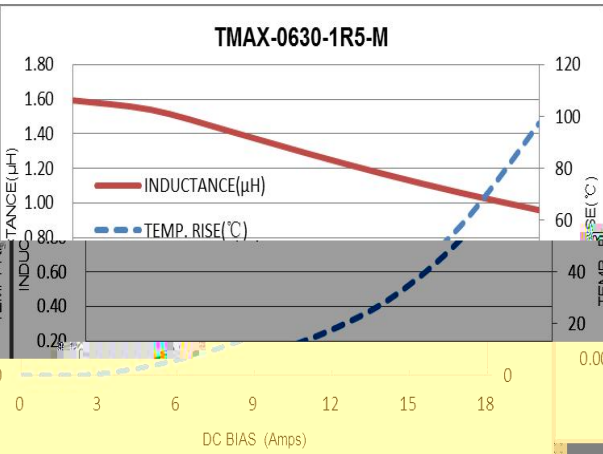
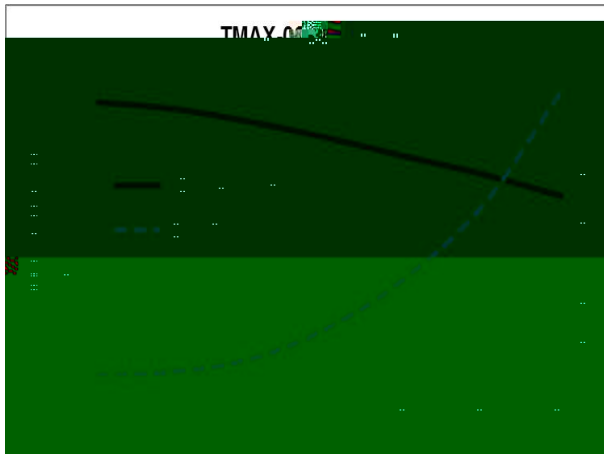
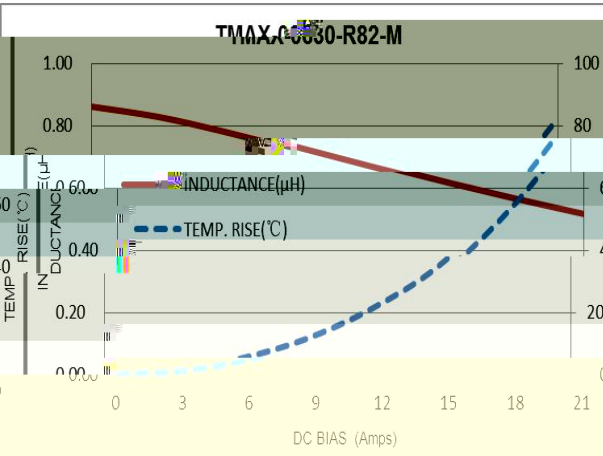
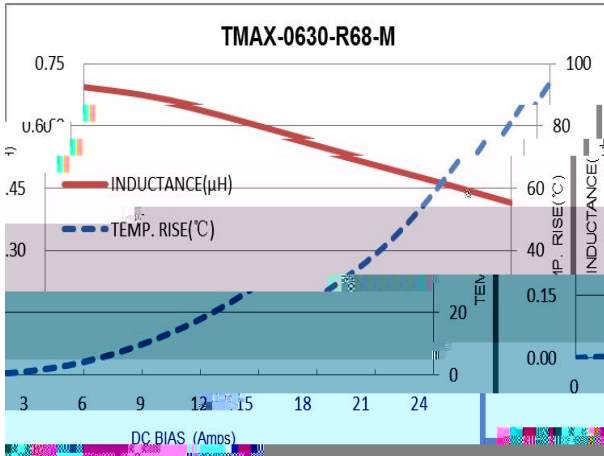
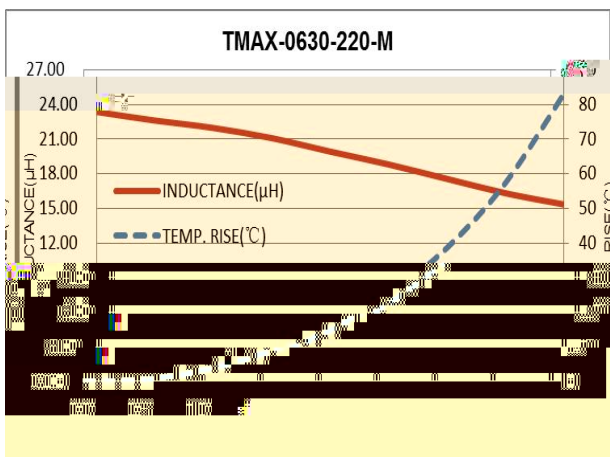
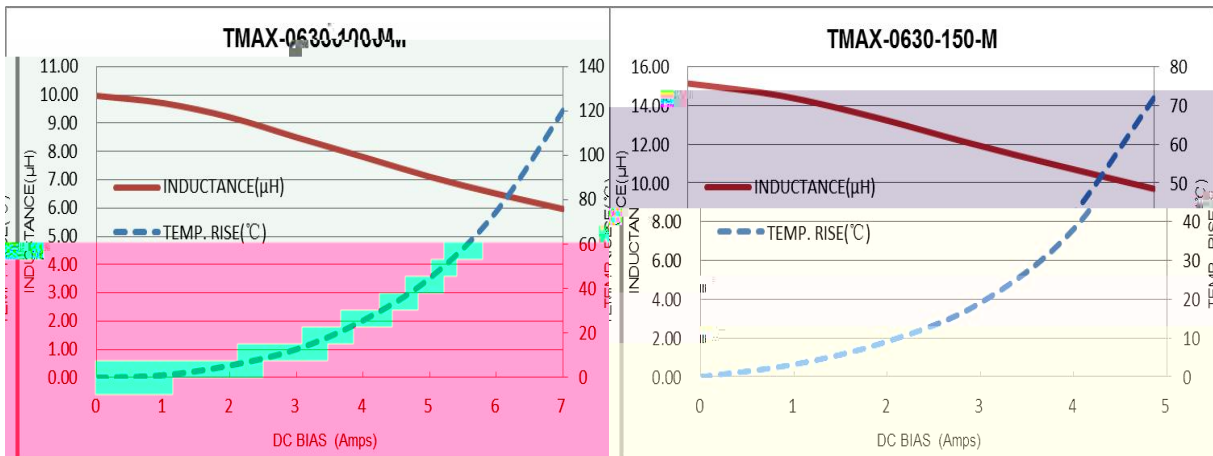
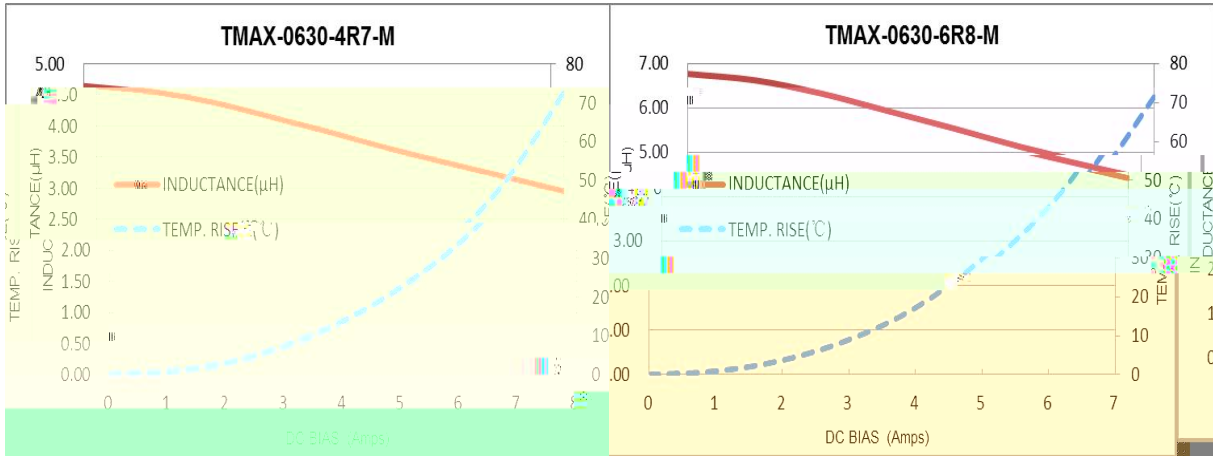

	\pm \pm \rightarrow \rightarrow \pm \pm \rightarrow	
		\pm
		\pm
		\pm
		\pm
		\pm

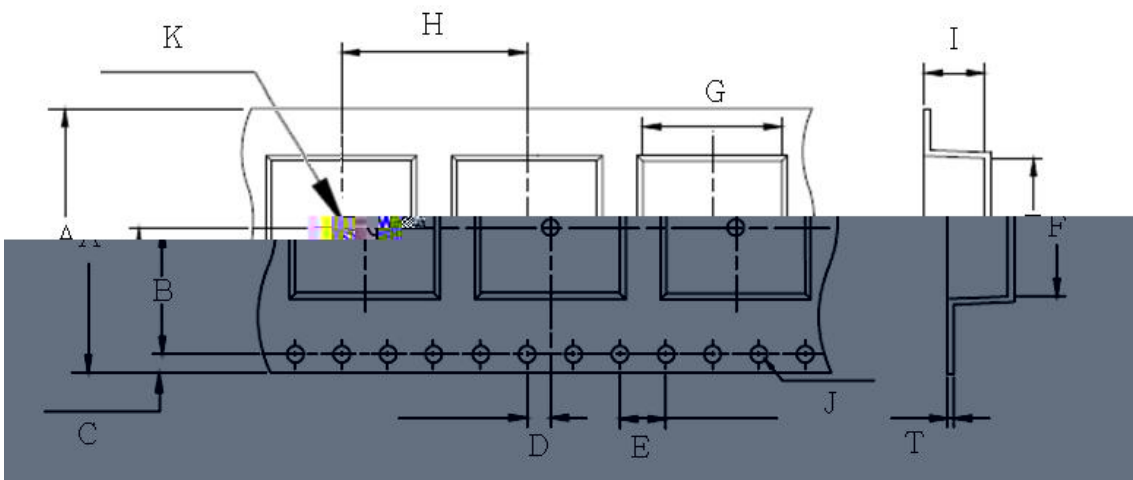

±	±	±	±	±	±
±	±	±	±	±	±

±	±	

~

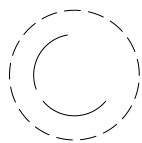

-
-

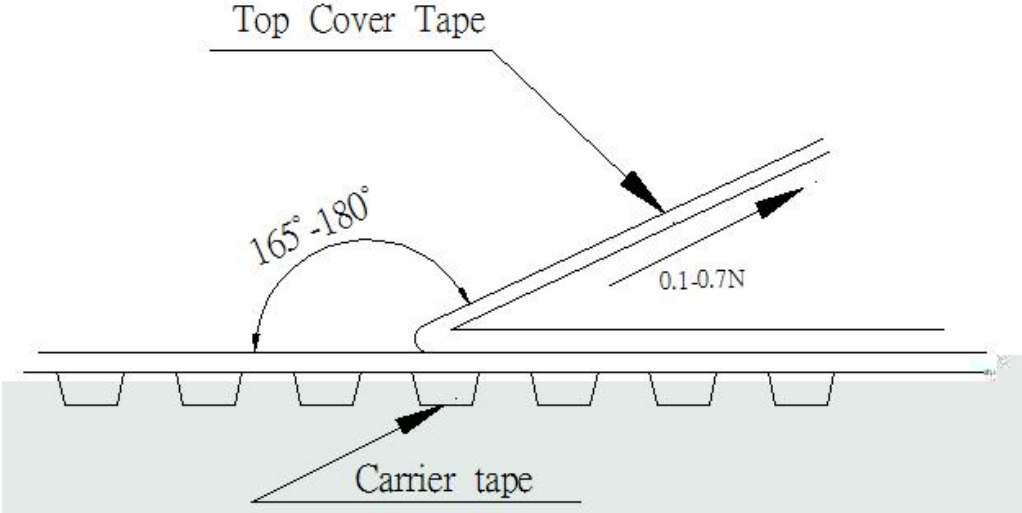

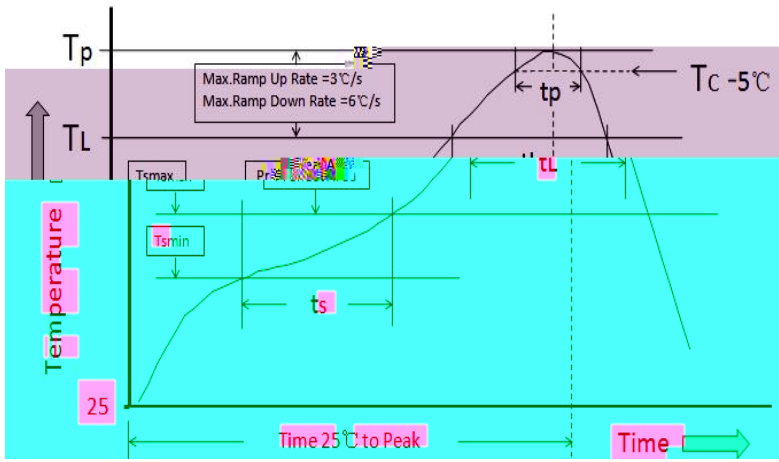

	<	=
<	$^\circ\text{C}$	$^\circ\text{C}$
=	$^\circ\text{C}$	$^\circ\text{C}$

	<		
<	$^\circ\text{C}$	$^\circ\text{C}$	$^\circ\text{C}$
	$^\circ\text{C}$	$^\circ\text{C}$	$^\circ\text{C}$
	$^\circ\text{C}$	$^\circ\text{C}$	$^\circ\text{C}$

	$^\circ\text{C}$	$^\circ\text{C}$
	$^\circ\text{C}$	$^\circ\text{C}$
	$^\circ\text{C}$	$^\circ\text{C}$
	$^\circ\text{C}$	$^\circ\text{C}$
$^\circ\text{C}$		
	$^\circ\text{C}$	$^\circ\text{C}$
$^\circ\text{C}$		

-

-

